

SERA
BATHROOM
—DESIGNS—

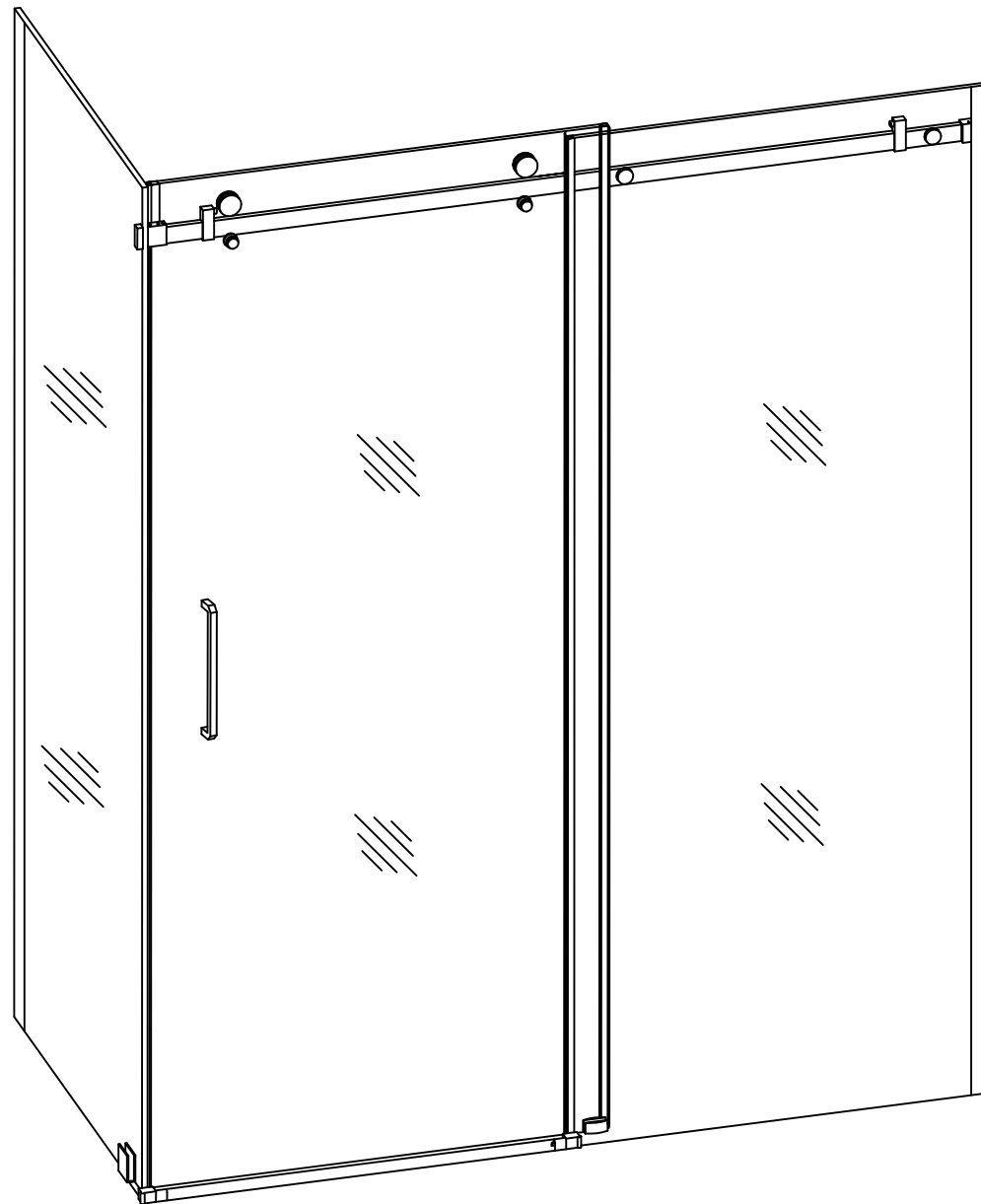

INSTALLATION AND OWNER'S MANUAL



Shower Door Model Number: S76-10-60x36

Please carefully read these instructions before you begin to install the products.

Final sealing

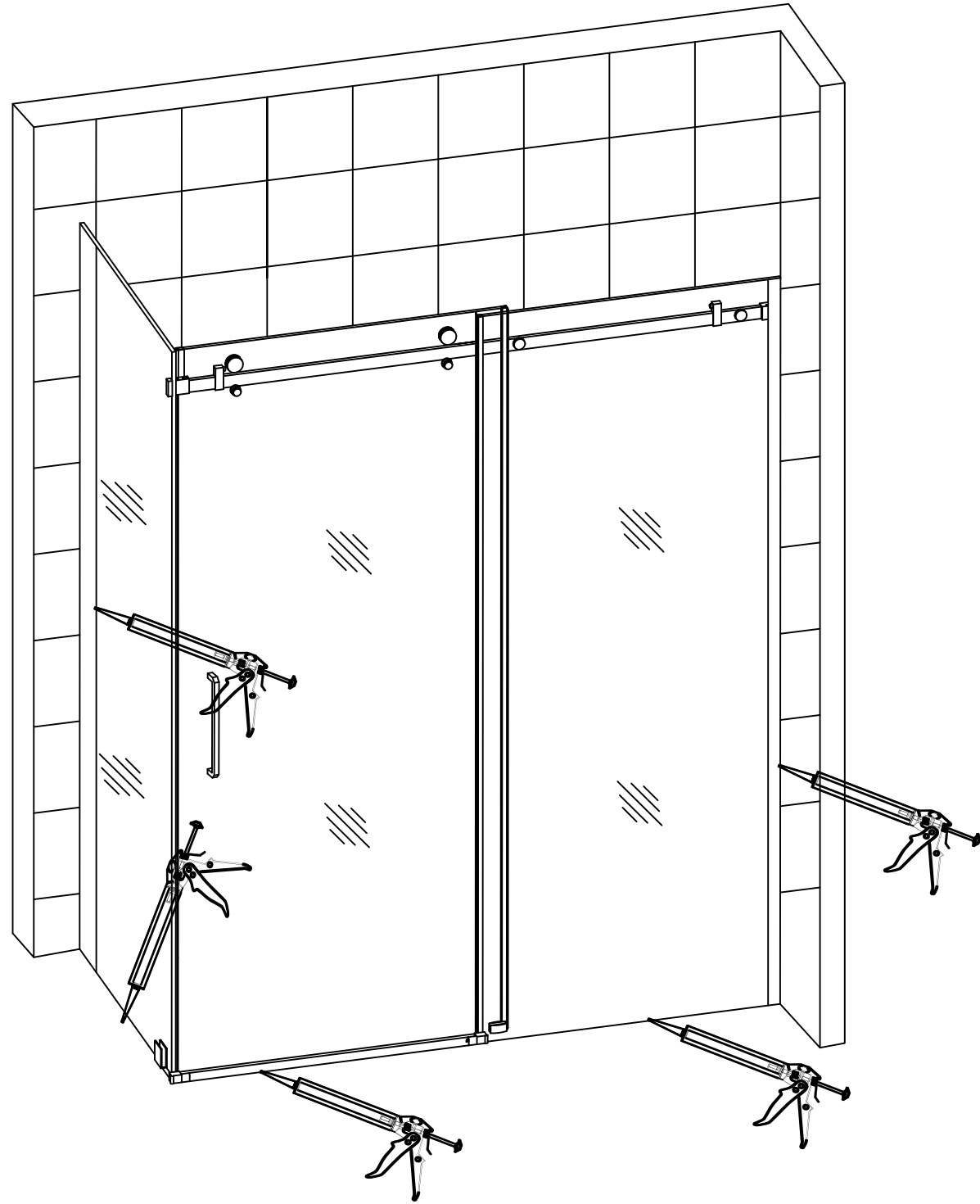

Using Bath & Kitchen silicone sealant, seal the fixed glass (3) and returned glass panel (23) along bottom edge on shower base, and side edge along shower wall. Next seal around sliding door track divider (9).

Before you start

Thank you for purchasing your shower enclosure. We hope that it will provide you with years of satisfying use and enjoyment.

Please read this manual carefully because it contains information and instructions about the proper installation of the unit. If you do not follow certain conditions of installation and maintenance, your warranty may be affected.

1. Before installation, inspect installation surfaces or level and have to the strength to support the heavy weight of this shower enclosure assembly. This Shower Enclosure should only be installed using the connection point to the studs or to pre-installed 2x6 wood reinforcements behind the wall.
2. This Shower Enclosures assembly is very heavy and requires professional installation.

Detailed Diagram of Shower Door Components

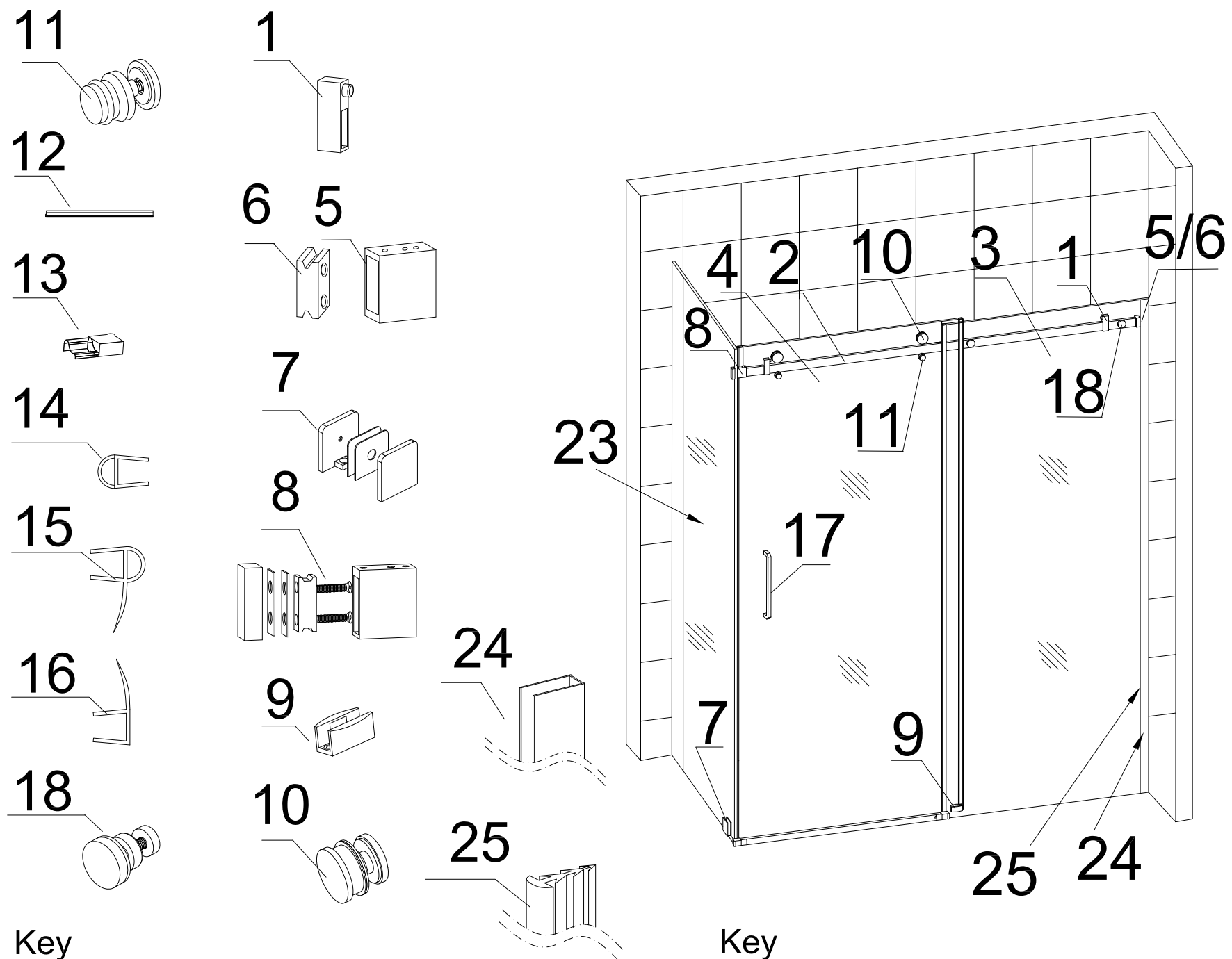

Key Number	Description	QTY	Key Number	Description	QTY
1	Door Stopper	2	14	Door Seal	1
2	Top Rail	1	15	Door Seal	1
3	Fixed Glass	1	16	Door Seal	1
4	Sliding Door	1	17	Door Handle	1
5	Rail End	2	18	Fixed Glass Bolt Assembly	2
6	Wall Mount	2	19	Screw Pack 1	1
7	Glass Clamp	1	20	Screw Pack 2	1
8	Rail Mount Assembly	1	21	Screw Pack 3	1
9	Sliding Door Track Divider	1	22	Screw Pack 4	1
10	Upper Wheel Assembly	2	23	Return Glass Panel	1
11	Bottom Roller Guide Assembly	2	24	Vertical channel	2
12	Door Threshold	1	25	U-channel Seal	1
13	Door Threshold End Cap	2			

PLEASE NOTE: During unpacking carefully inspect all parts and use the exploded view drawing to identify all parts in the parts listing. Before discarding the packaging check for any parts or small hardware bags that may have been overlooked.

Installing the door handle

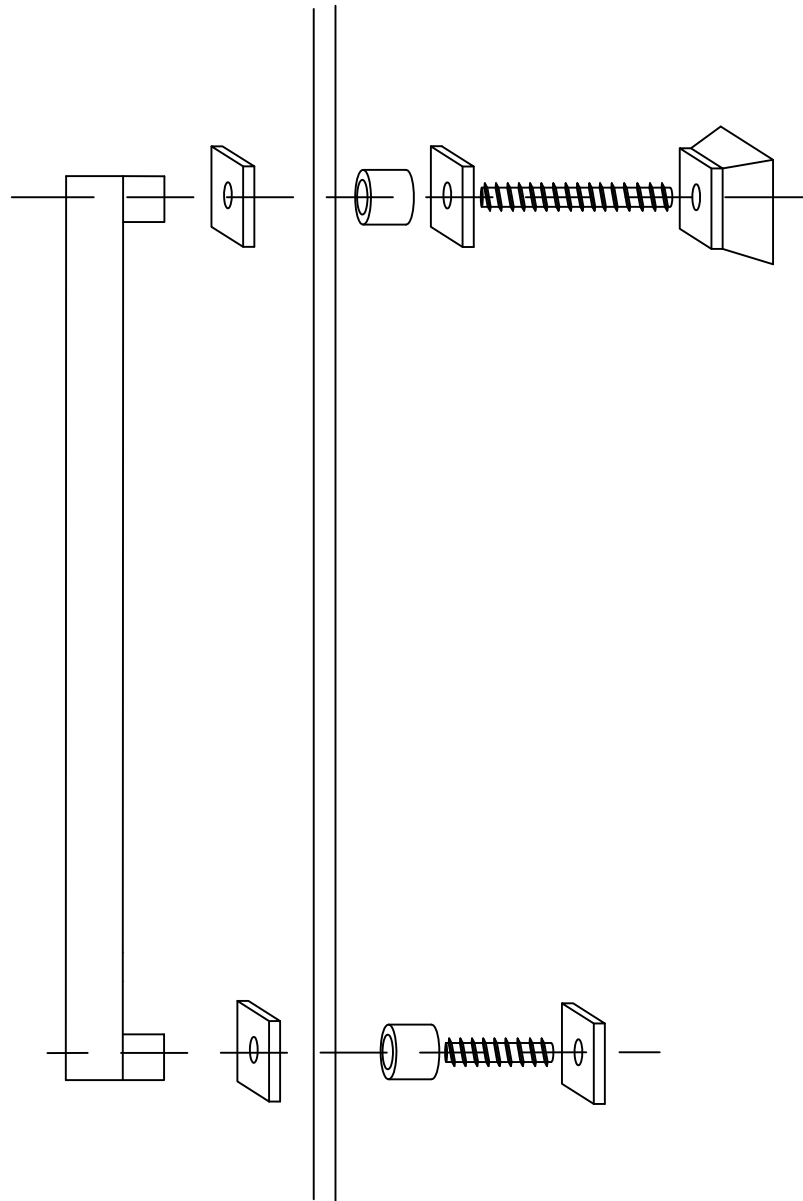



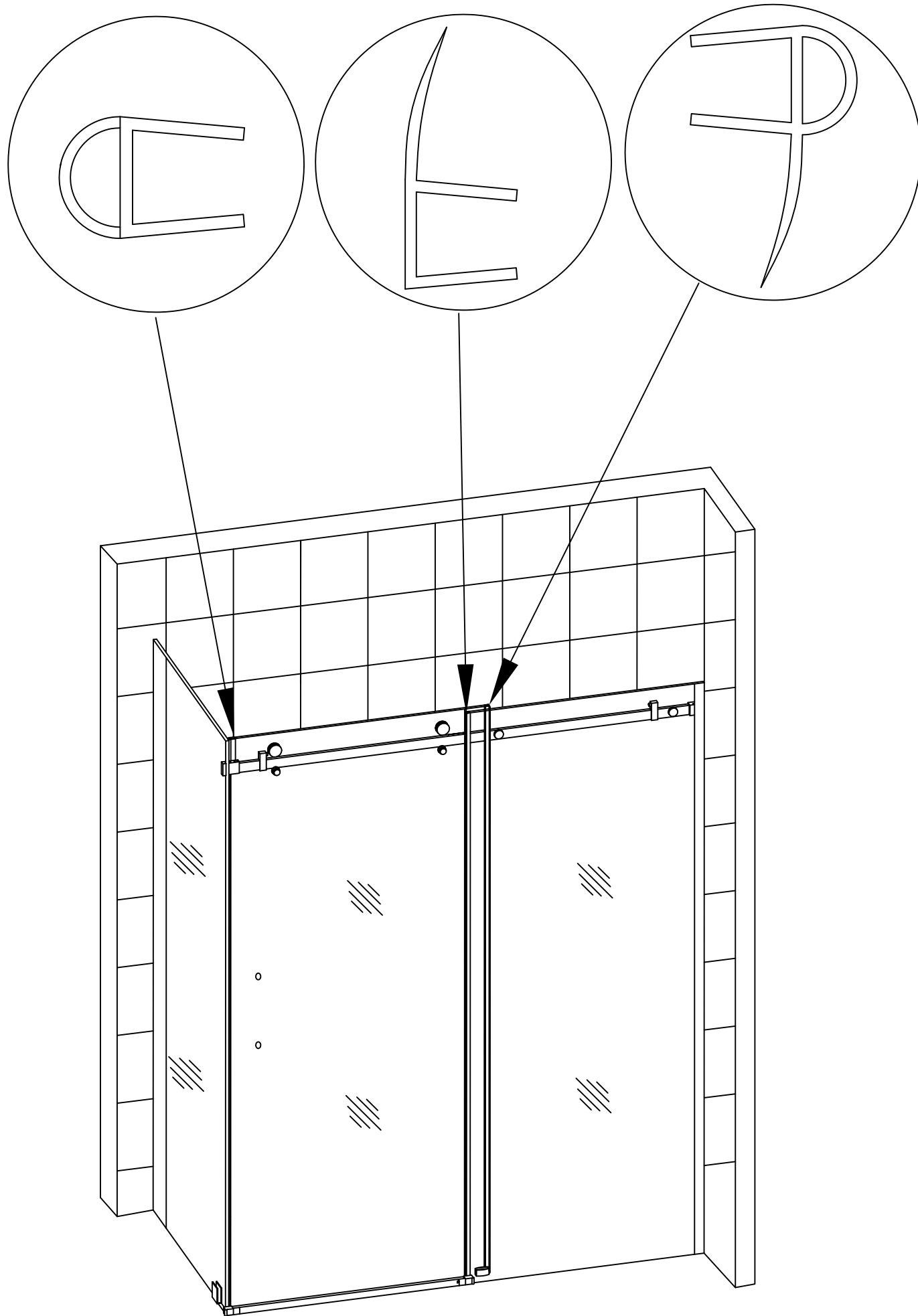

Install the door handle (16) using hardware provided. Follow the assembly sequence seen in drawing.

Installing the door seals

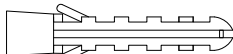
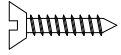
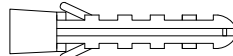

Install the door seals according to the drawing.

SUPPLIED HARDWARE

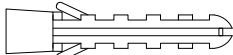
SCREW PACK (1)	M4x40		5
	Anchor		5
SCREW PACK (2)	M4x40		2
	Anchor		2
SCREW PACK (3)	M4x40		2
	Anchor		2
SCREW PACK (4)	M4x40		4
	Anchor		4

SUPPLIED PARTS

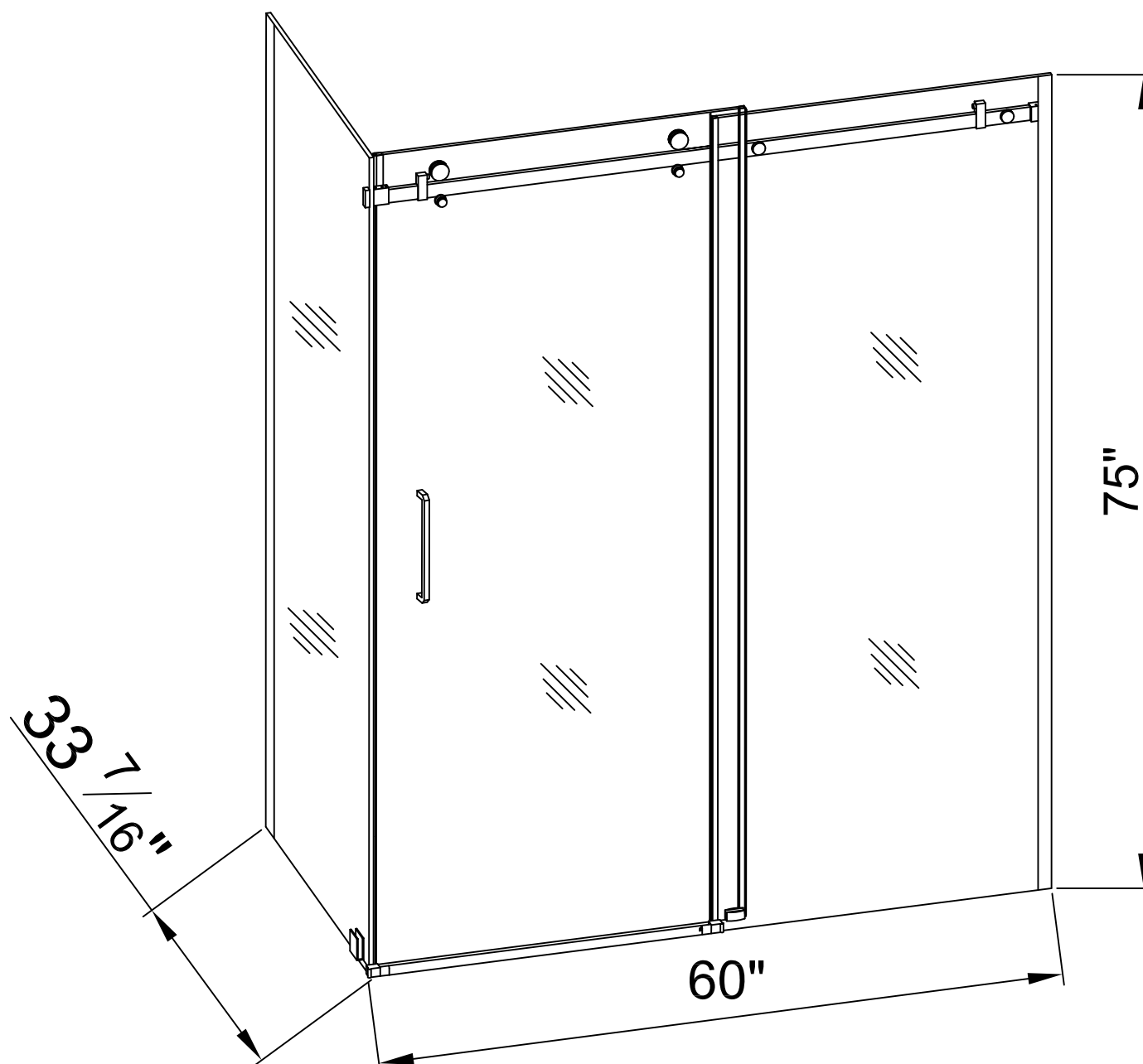

Installation Guide

Please read and follow the installation instructions and guidelines in this section. Failure to follow the recommended instructions and installation techniques may lead to possible damage to the unit or the surrounding area. This can affect warranty claims.

ATTENTION: This unit requires assembly. A minimum of two people are required for assembly, as several of the sections can be large and unstable until assembled.

You will need the following tools:

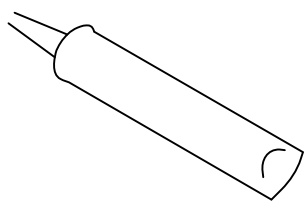

Caulk

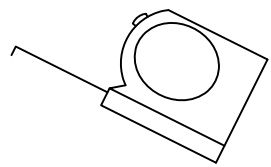

Tape Measure

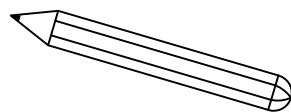

Pencil

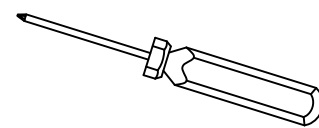

Phillips Screwdriver

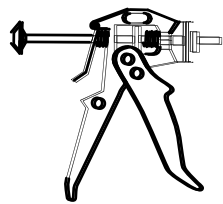

Caulk Gun



Level

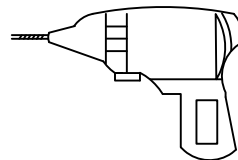

Electric Drill

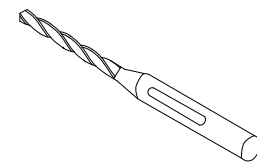

Drill bit (ø1/4")

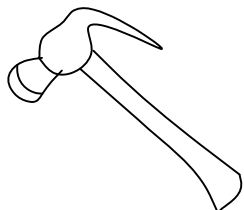

Hammer

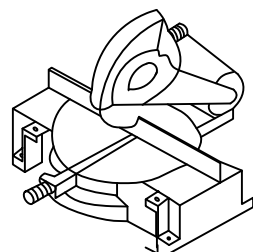

Miter saw or Hacksaw

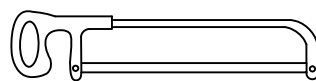

Locate the accessory box and remove the individual screw and hardware packages. Lay them out in sequential order to aid in completing the rest of the installation.

NOTE: If your surface is prone to cracking or chipping then it is recommended that you pilot drill first using a smaller drill bit, and then step up to the final size.

4. Using the appropriate drill bit for your floor surface drill the hole locations with a 5/16" diameter drill bit. Install the plastic anchors from Screw pack 3 into the drilled holes. Repeat for the other side. See figure 4
5. Add a small amount of silicone sealant to bottom of threshold bar assembly place into position. See figure 5
6. Using the hardware from screw pack 4 install the threshold bar assembly. See figure 6

Install the Door Threshold

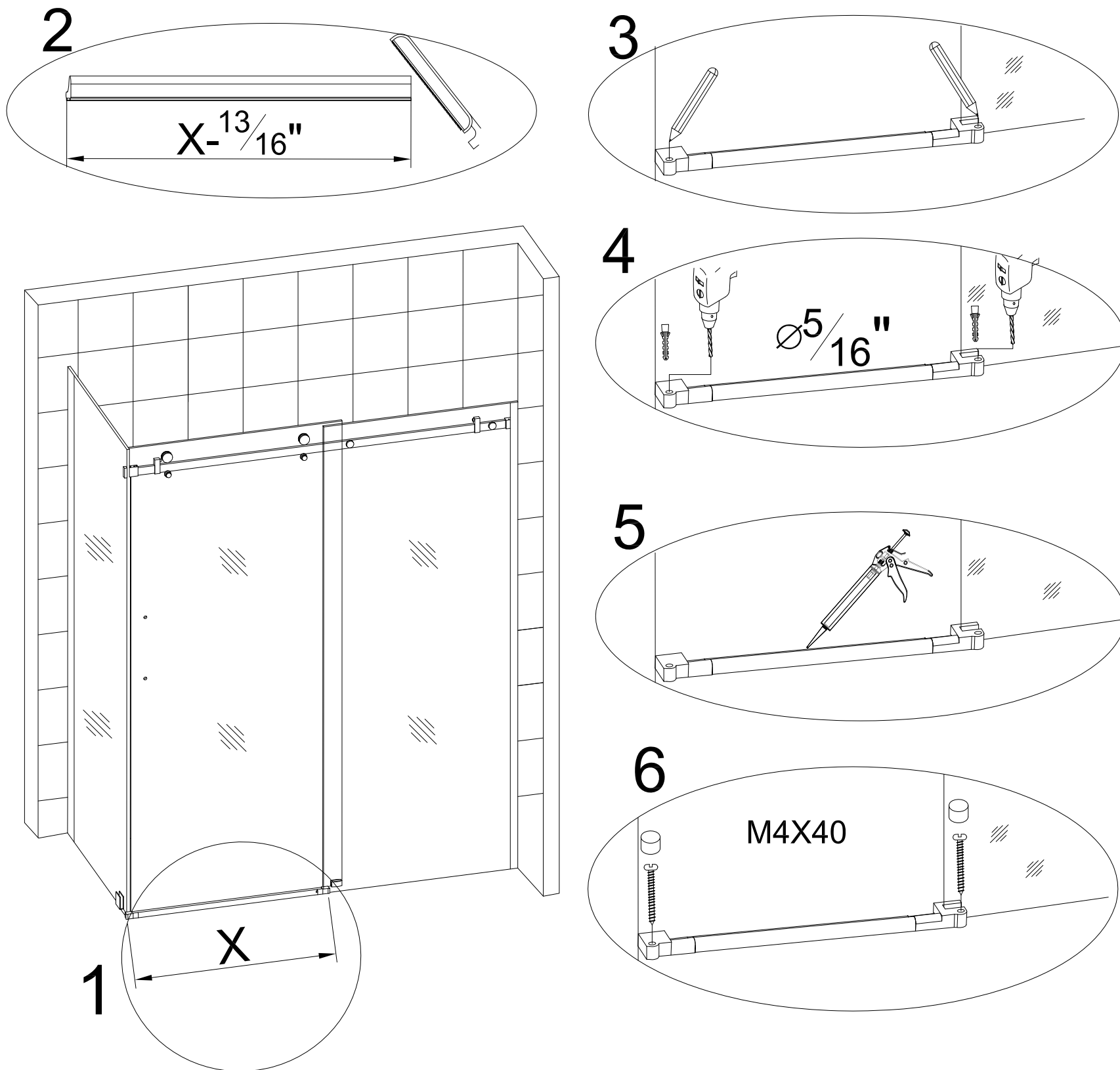

The Door Threshold is used to prevent water from seeping out while bathing. Install the threshold according to these instructions.

1. Measure the distance between the fixed glass (3) and the shower wall. See figure 1.
2. Using a hacksaw cut the threshold bar (12) to fit distance measured between the fixed glass and shower wall. Remove any sharp edges or burrs after cutting threshold bar (12). See figure 2
3. Position the threshold bar (12) to floor by aligning in door opening with fixed glass (3). Mark the threshold end cap (13) mounting hole locations. See figure 3

Reverse Door opening

This shower door is reversible for left and right installation. The drawings below illustrate a left installation as the door opens from the left to right.

Note the location of the fixe glass panel for this left installation.

LEFT INSTALLATION

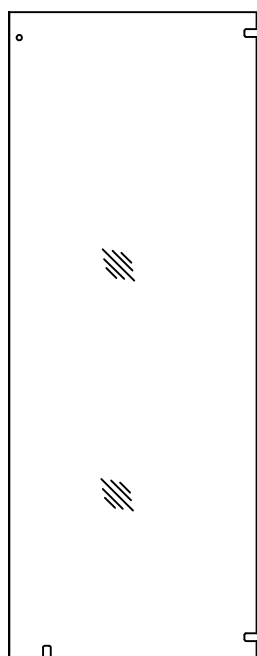
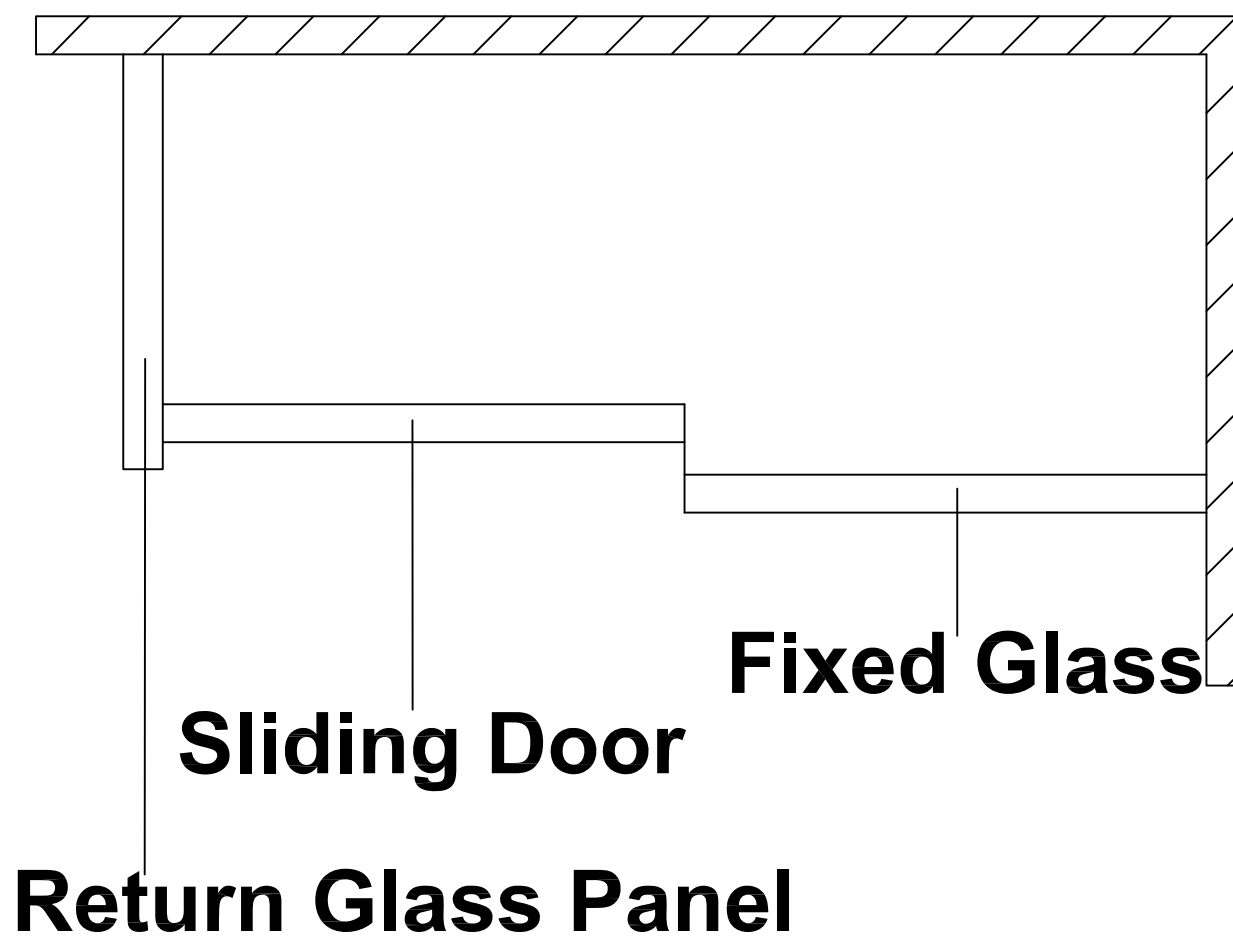

Return Glass Panel

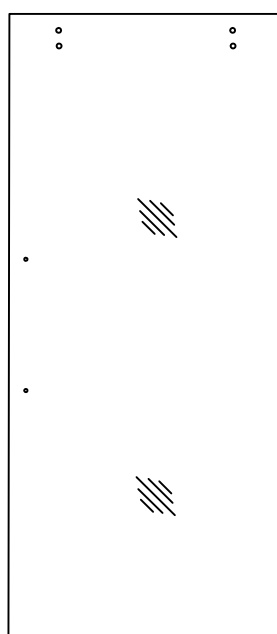

Sliding Door

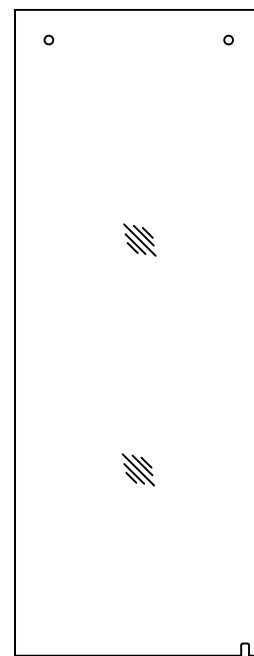

Fixed Glass

If you wish to install the door on the right. Flip the top rail installation so that the Fixed Glass (3) is on the left when installed.

Measure the distance

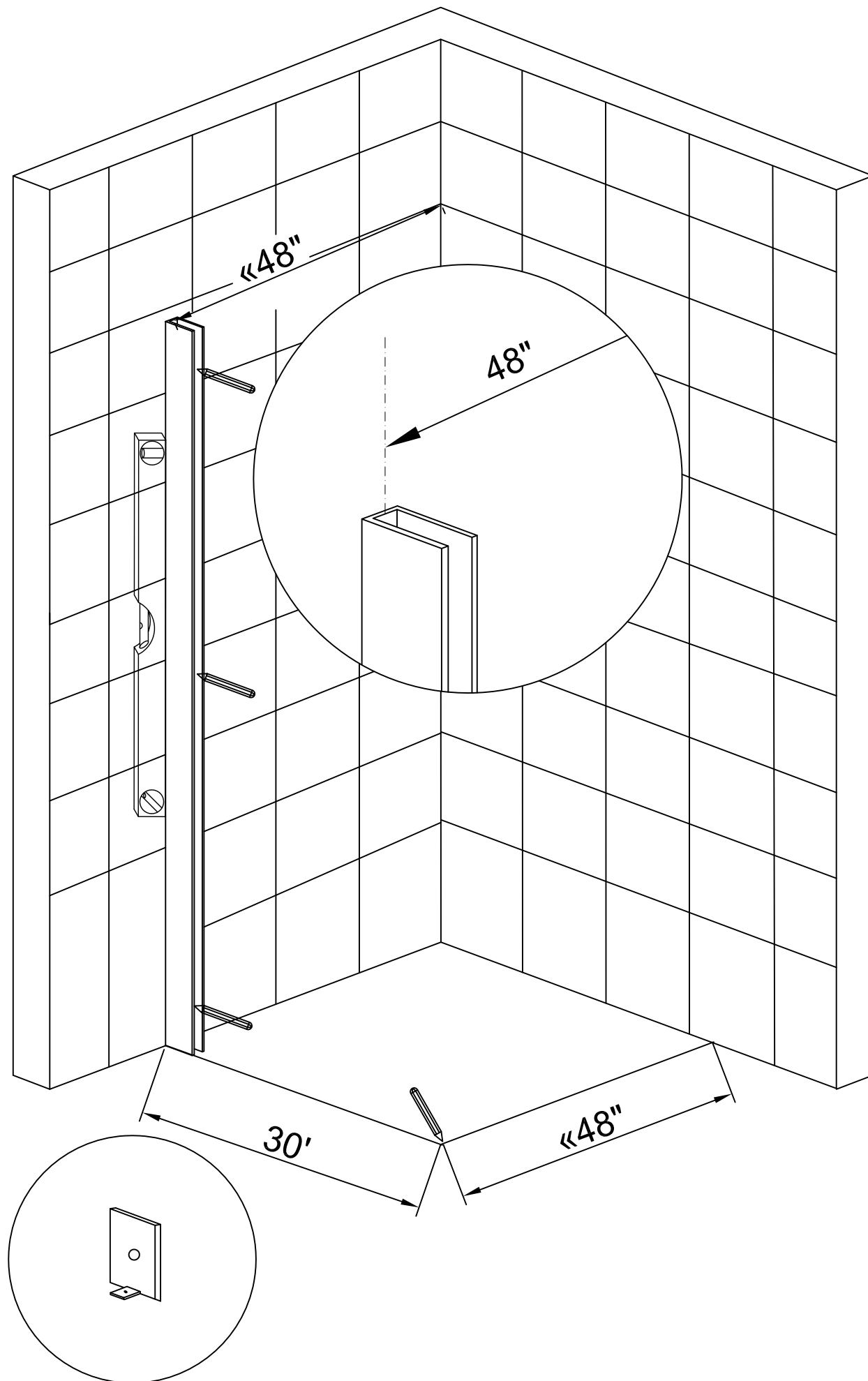

Install all of the wall material or materials you intend to use before installing the glass clamps and return glass panel, this includes all moisture resistant wall board or rock board, tile, stone or other wall covering.

Refer to the drawing above and measure and mark the shower wall and floor for drilling locations to attach glass clamps and Vertical channel(25).

Hanging the Door

UPPER ROLLER CAM ADJUSTMENT

Rotate the outer edge of roller assembly using the small hex,

while holding the large hex wrench in place.

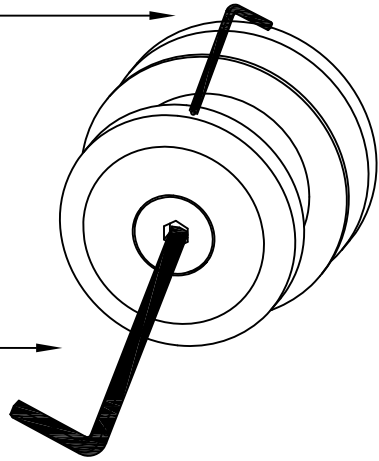

Bottom Roller Guide Assemblies

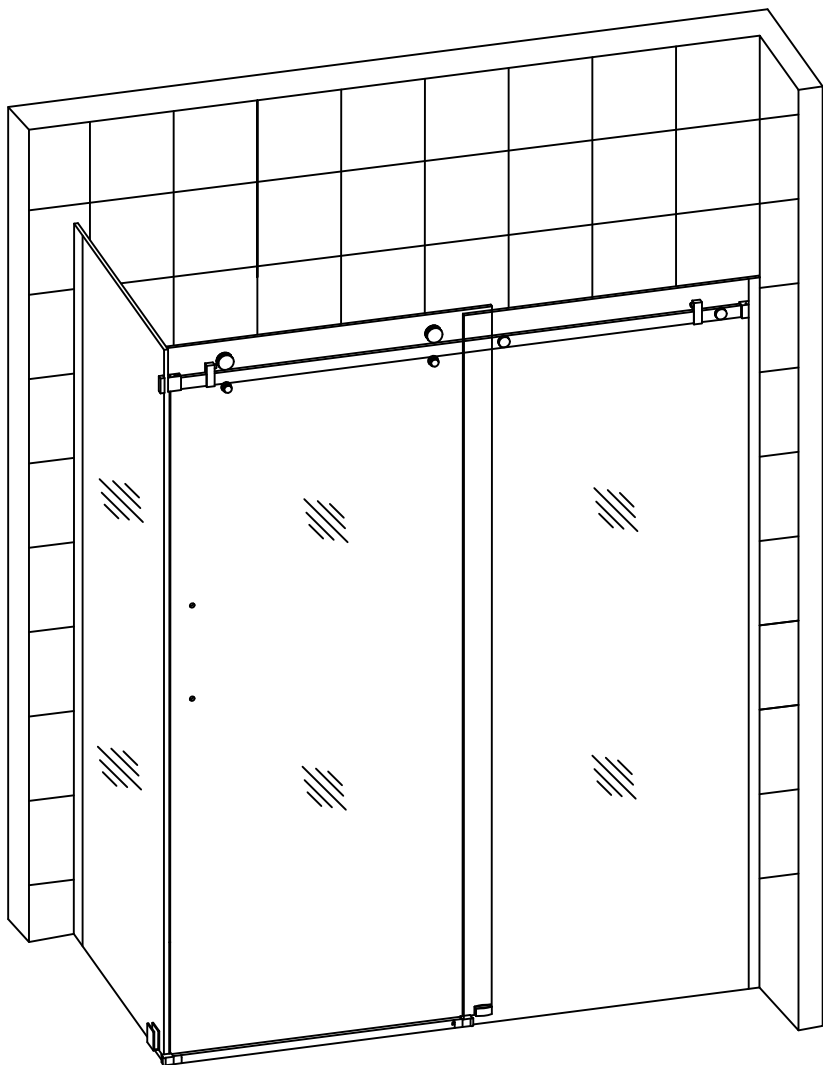
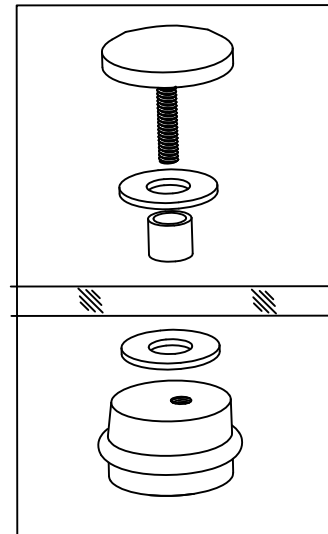

End View

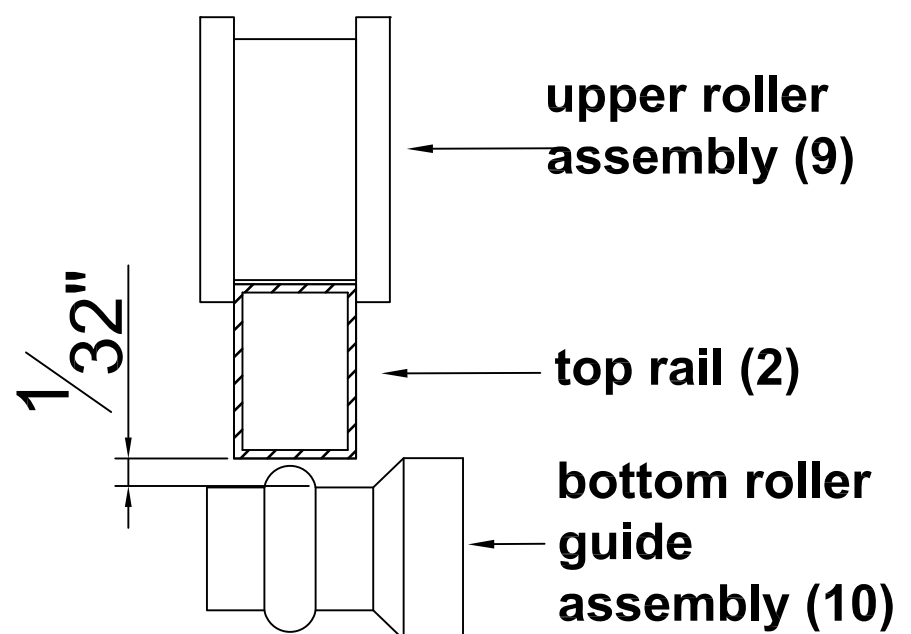

Suspend the sliding door (4) on the top rail (2). Slide the bottom edge of sliding glass door (4) into the groove of the sliding door track divider (8). Adjust the fasteners on both upper roller assemblies (9) to insure the bottom edge of sliding glass door (4) does not touch the bottom of sliding door track divider (8). Install the bottom roller guide assemblies (10) on the sliding door (4) to secure the sliding glass door (4) to top rail (2). Adjust the bottom roller guide assemblies (10) so that the distance between the bottom of top rail (2) and the top of bottom roller guide assemblies (10) has a gap of $\frac{1}{32}$ ". This gap is a starting gap, check that the sliding door rolls smoothly along the top rail. Make adjustments if needed.

Install Wheel Rollers onto the Door

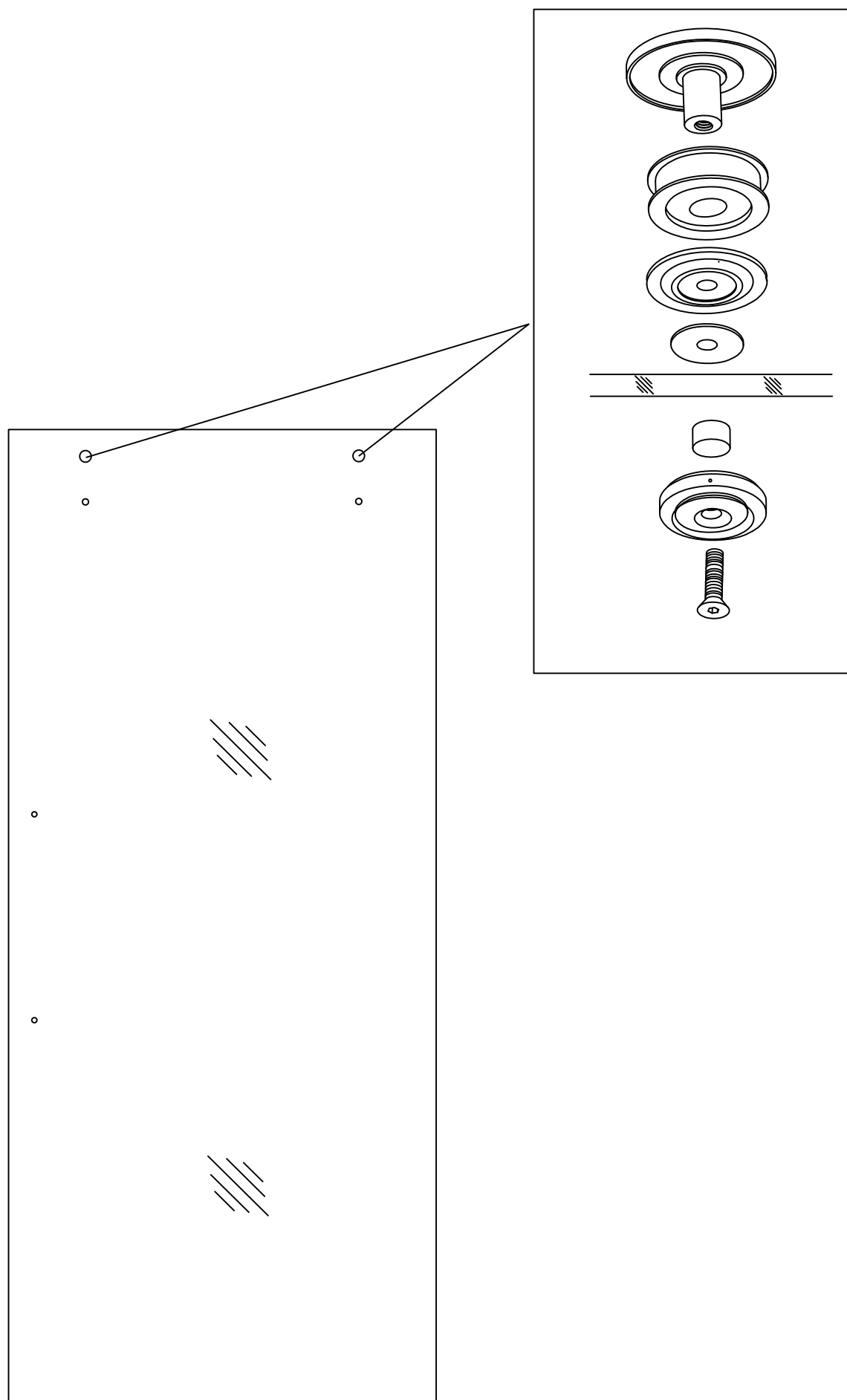

Assemble the upper roller assemblies (9) onto sliding door (4) as seen in figure 1

Note: The door handle mounting holes should be positioned to left. The upper roller assemblies (9) will be on the outside of sliding door (4). The sliding door should be to the inside of shower area.

Installation of Vertical channel and glass clamps

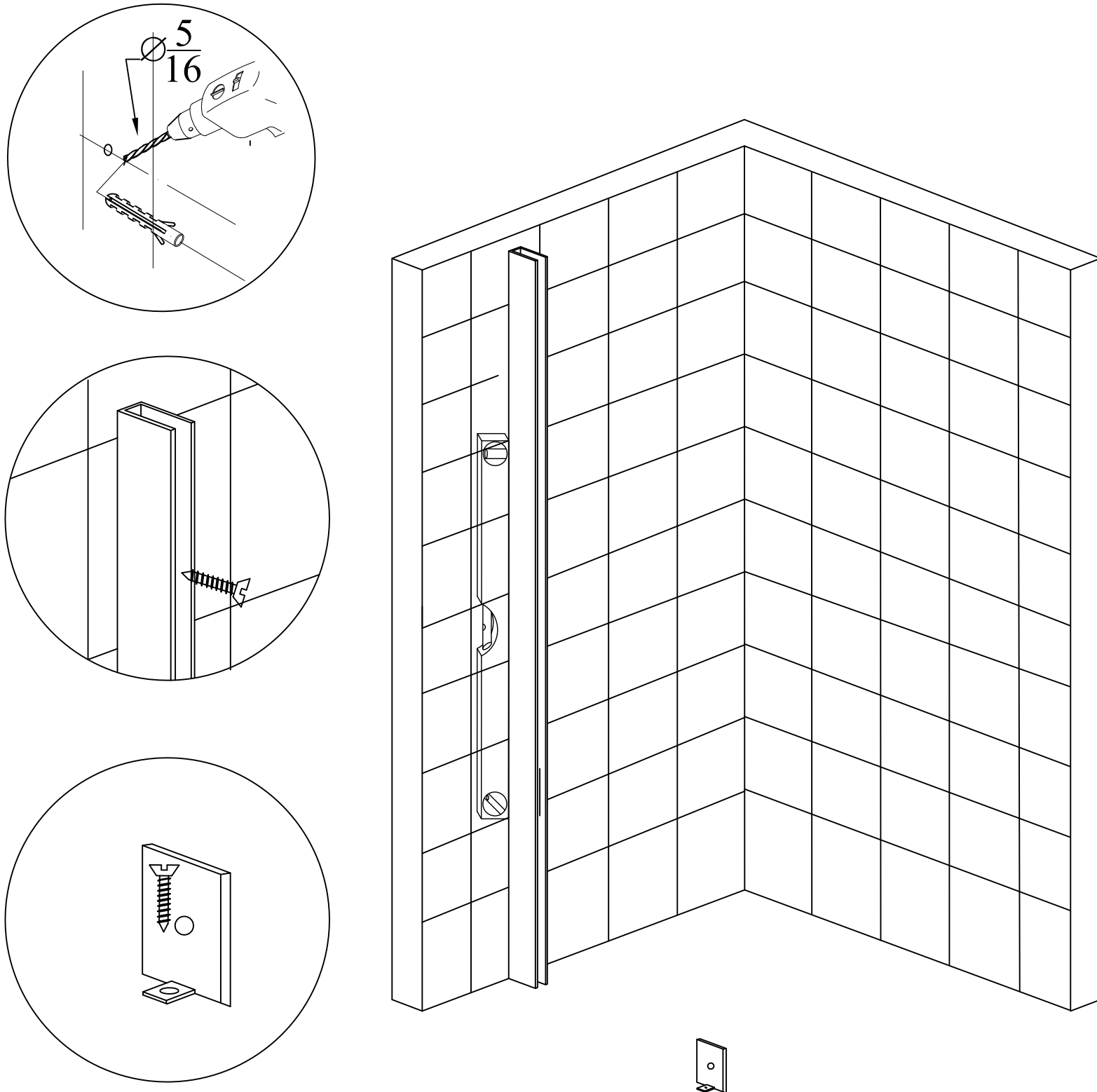

Using the appropriate drill bit for your wall and floor surface drill each hole location with a 5/16" diameter drill bit. Install the plastic wall anchors provided into the drilled holes

NOTE: If your surface is prone to cracking or chipping then it is recommended that you pilot drill first using a smaller drill bit, and then step up to the final size.

Using screw pack (4) attach the Vertical channel (24) to wall and attach the glass clamps (7) to shower floor using M4x40 screws.

Installation of return glass panel

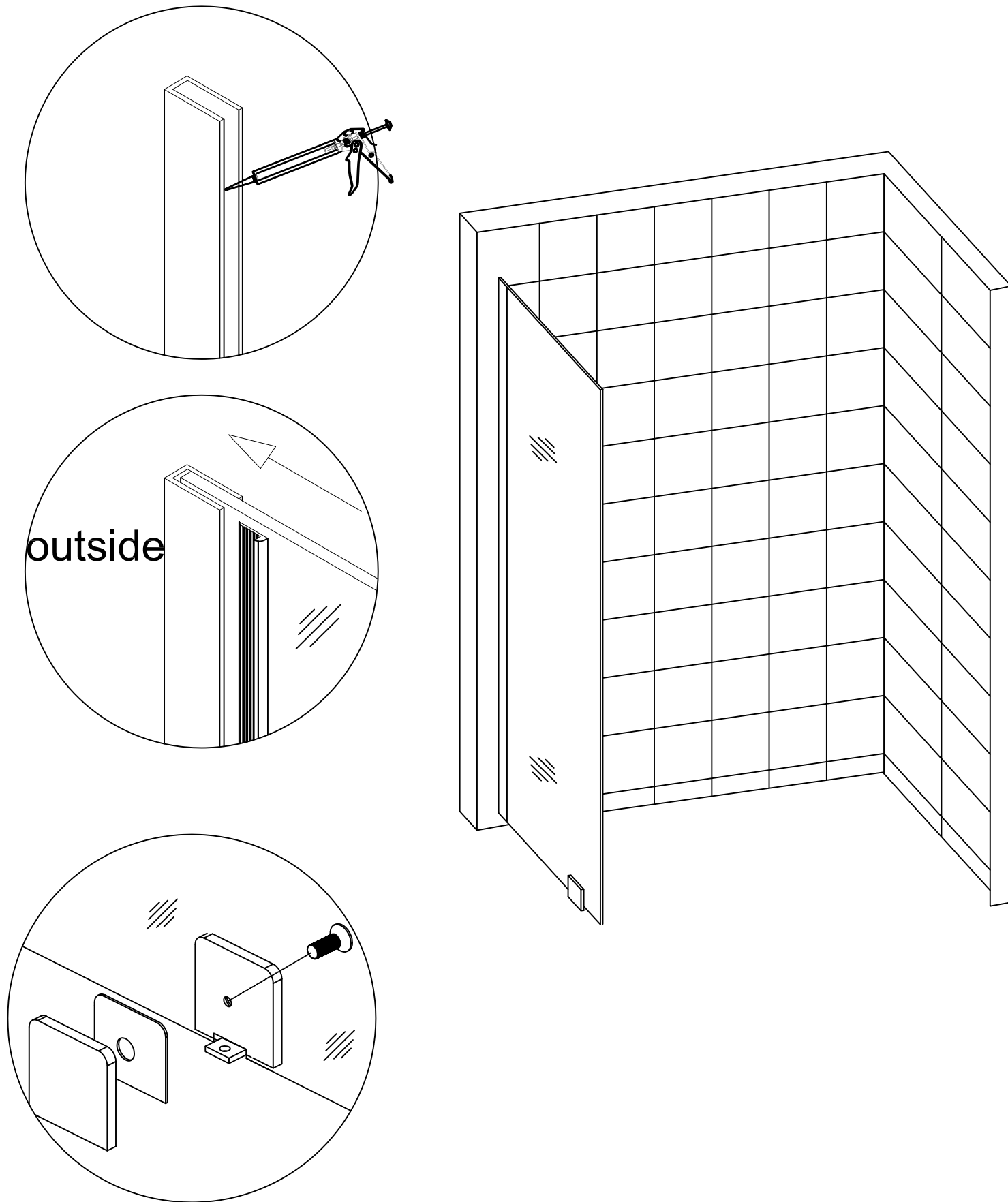

Set properly check for level and plumb and then apply a small neat bead of 100% clear silicone to the inside bottom of the Vertical channel (24) .

Install return glass panel (23) to Vertical channel (24) and glass clamp (7).

Install U-channel Seal (25) to return glass panel (23).

NOTE: If your surface is prone to cracking or chipping then it is recommended that you pilot drill first using a smaller drill bit, and then step up to the final size.

2. Using the appropriate drill bit for your wall surface drill the hole locations with a 5/16" diameter drill bit. Install the plastic anchors provided into the drilled holes. Repeat for the other side.
3. Remove the wall mounts (6) from the rail ends (5). Using the hardware from Screw Pack 1, install the wall mounts (6) on the wall. Repeat the installation on the other side.
4. Reinstall the rail ends (5) onto both ends top rail (2), so the the top rail (2) end is exposed.

ATTENTION: A minimum of two people are required for the next assembly steps.

5. Position the top rail / fixed glass assembly into place in your shower opening. Slide the rail end (5) over the wall mount (6) and secure using the set screw. Repeat on other side.
6. Set properly check for level and plumb and then apply a small neat bead of 100% clear silicone to the inside bottom of the Vertical channel (24) .Install fixed glass (3) to Vertical channel (24) and Install U-channel Seal (25) to fixed glass (3).
7. Insure plastic sliding door glide is in place in underside of sliding door track divider (9) and positioned to proper location for 10mm glass thickness. See figure 7.
8. Position the sliding door track divider (9) into position as seen in figure 8 and mark the 2 shower tray hole positions. **Note: In drawing 8 the hole locations for attaching sliding door track divider should be 1 3/16" from edge of fixed glass. See details in figure 8.**

NOTE: If your surface is prone to cracking or chipping then it is recommended that you pilot drill first using a smaller drill bit, and then step up to the final size.

9. Using the appropriate drill bit for your floor surface drill hole locations with 5/16" diameter drill bit and install the plastic anchors from screw pack 2 into the drilled hole. Position the sliding door track divider (9) over drilled holes on floor, and secure sliding door track divider (9) to floor using hardware in screw pack 2. See figure 9.

Mounting the Top Rail mounts Brackets

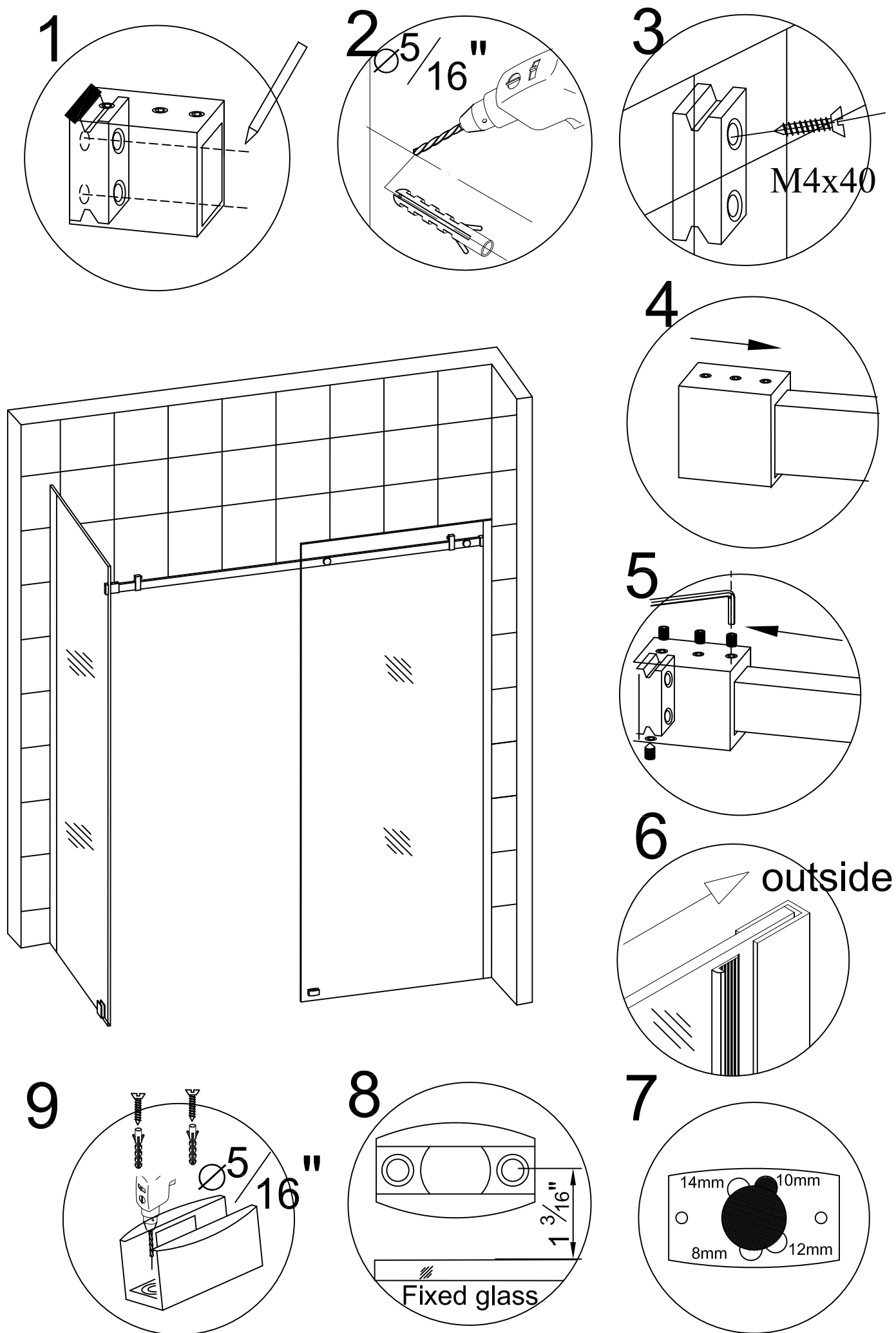

1. Remove the rail ends (5) from the top rail (2). Install the wall mounts (6) into one of the rail ends (5), using the set screw to locate the Wall Mount (6) within the rail end (5). A hex wrench is provided for this set screw.

Place the rail end (5) with wall mount installed onto the location you marked in earlier step and mark the mounting holes. Use only the top hole. Repeat for the other side.

Shower Door Installation

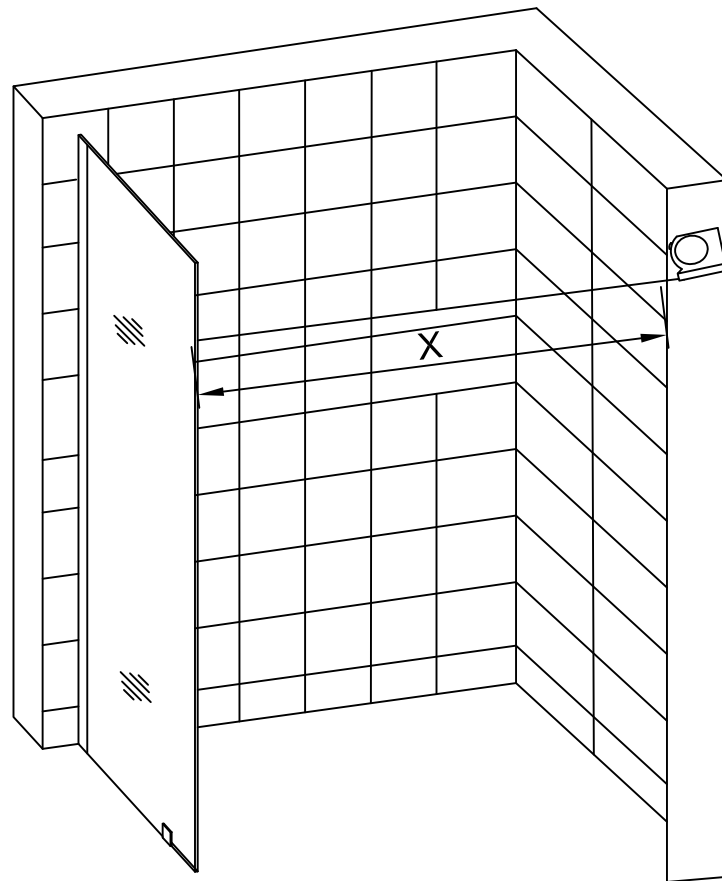

1. Install all of the wall material or materials you intend to use before measuring the width of the opening. This includes all moisture resistant wall board, rock board, tile, stone or other wall covering.
2. Measure the width of the shower opening at the top between the 2 walls. Note this is dimension "X".

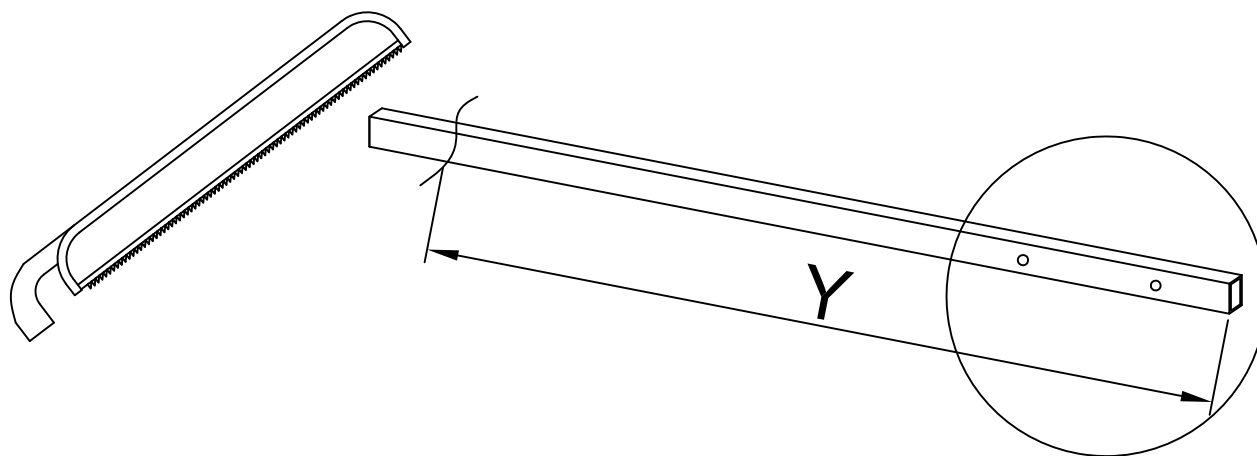

The following equation is used to determine the length to be cut from the rail in order to fit the shower opening.

$$Y = X - 1"$$

3. Measure distance "Y" from the end of the Top Rail (2) with mounting holes and mark the rail.
4. Using a Hack saw or Jig saw cut the Top Rail (2) at the mark. Carefully remove any burrs or sharp edges remaining on Top Rail (2) after the cutting.

Mark the Top Rail Location

ATTENTION: A minimum of two people are required for the next assembly steps.

Preassembly the top rail onto the fixed glass to locate the mounting points on the wall relative to your desired location.

Painters tape or masking tape in the general location of the of the final installation will aid in marking the wall and floor.

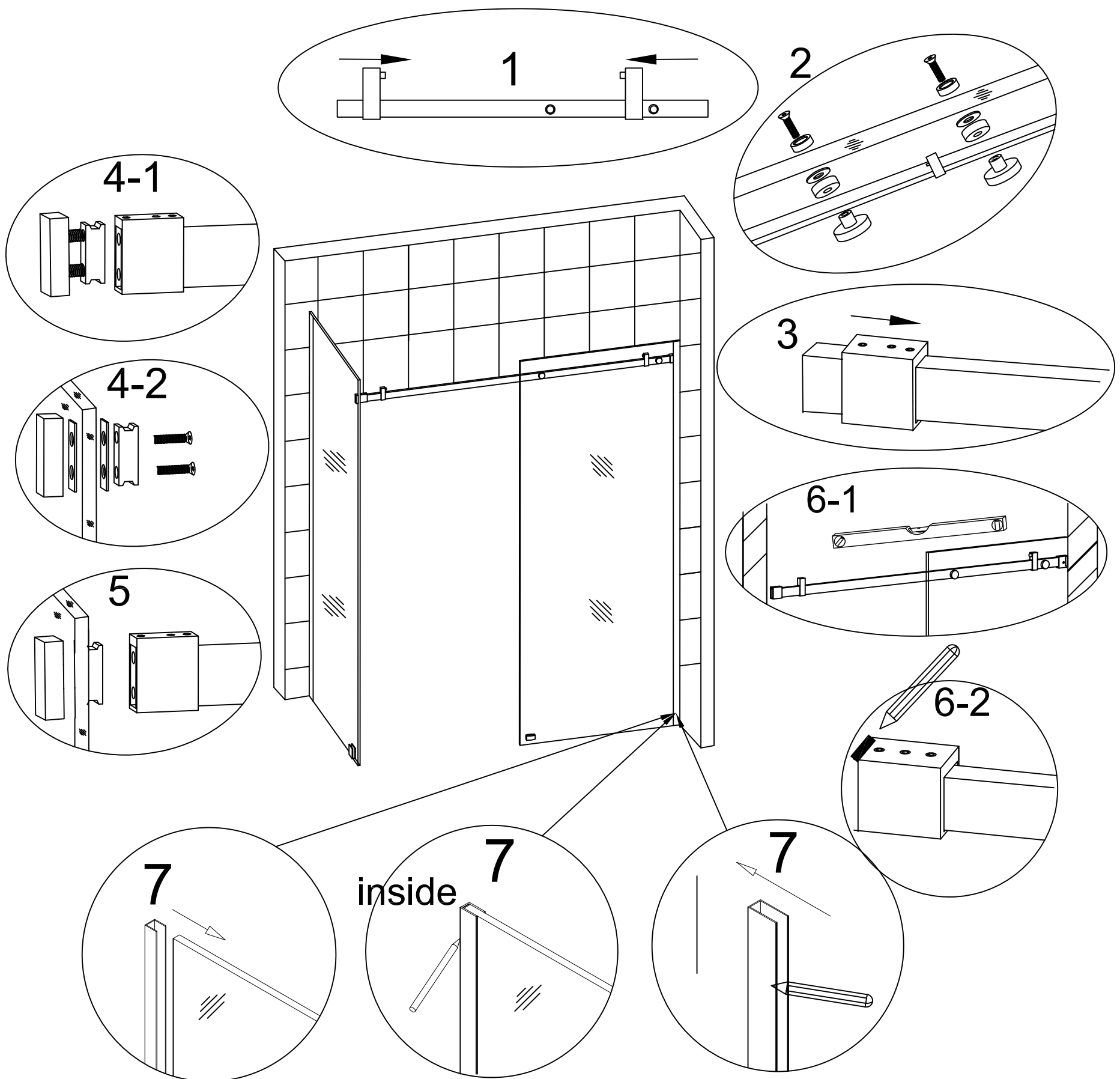

1. Slide the door stoppers (1) onto each end of the the top rail (2). The bumpers on door stoppers (1) should face inward and be on top for final installation. See figure 1.

2. Assemble top rail (2) to fixed glass (3) following the assembly sequence shown in figure 2. Note the door stopper (1) is positioned between the Fixed Glass assembly hardware. See figure 2. Note: The top rail (2) is attached to the inside of the fixed glass (3). Install both rail ends onto the rail.
3. Loosen set screw on rail ends (5) and remove wall mounts (6) from rail ends (5). Next slide rail ends (5) onto each end of top rail (2). See figure 3.
4. Locate the rail mount assembly (8) and remove the brass fitting and glass connector parts from the metal sleeve. Loosen the set screws in metal sleeve and slide onto end of top rail (2) making sure the end of sleeve which is threaded is facing toward end of top rail. Loosely tighten set screws in metal sleeve to secure. See figure 4-1

Next assembly the cap mount assembly to top hole in return glass panel (5) following the assembly sequence shown in figure 4-2. The brass fitting should be positioned to the inside of return glass panel (5) when complete.

5. Position the top rail fixed glass assembly into place in your shower. Loosen the set screws in metal sleeve next to return glass panel (5). Next connect the metal sleeve to brass fitting. Tighten set screws in metal sleeve. See figure 5.
6. Place the fixed glass top rail assembly into your desired location.

Note: The top rail (2) attached to fixed glass (3) should face inside the shower.

Using a level, verify the top rail (2) is horizontal and the fixed glass (3) is plumb. Using a pencil, mark the rail ends onto the wall.

7. Insert the Fixed glass(3) into the Vertical channel (24). Mark the position of Vertical channel (24) on shower wall. Position the Vertical channel (24) with marked line on shower wall and mark the hole locations for attaching the Vertical channel (24) to the shower wall. See figure 7

NOTE: If your surface is prone to cracking or chipping then it is recommended that you pilot drill first using a smaller drill bit, and then step up to the final size.

8. Using the appropriate drill bit for your floor surface drill hole locations with 5/16" diameter drill bit and install the plastic anchor from screw pack 1 into the drilled hole for the Vertical channel (24).