

24" LED Mirror: Bali Series

Model: M-24BFFR

Size: 600*750*46MM

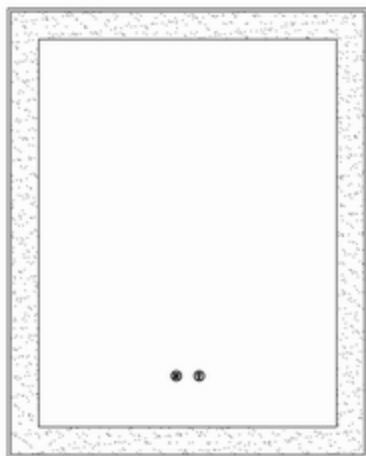

LED Lighted Mirror with Frosted Edge

Installation • Operation • Safety • Warranty

Support:

 support@serabathroomdesigns.com

 1-833-411-7372

 www.serabathroomdesigns.com



Matte black
aluminum



Backlit LED with
acrylic diffuser



Keeps the mirror
clear after showers



Touch sensor
switch



6000k



Control the brightness
to suit your needs



Modern and clean look,
perfect for bathrooms
or vanities



Four sides
frosted lighted

PRODUCT FEATURES

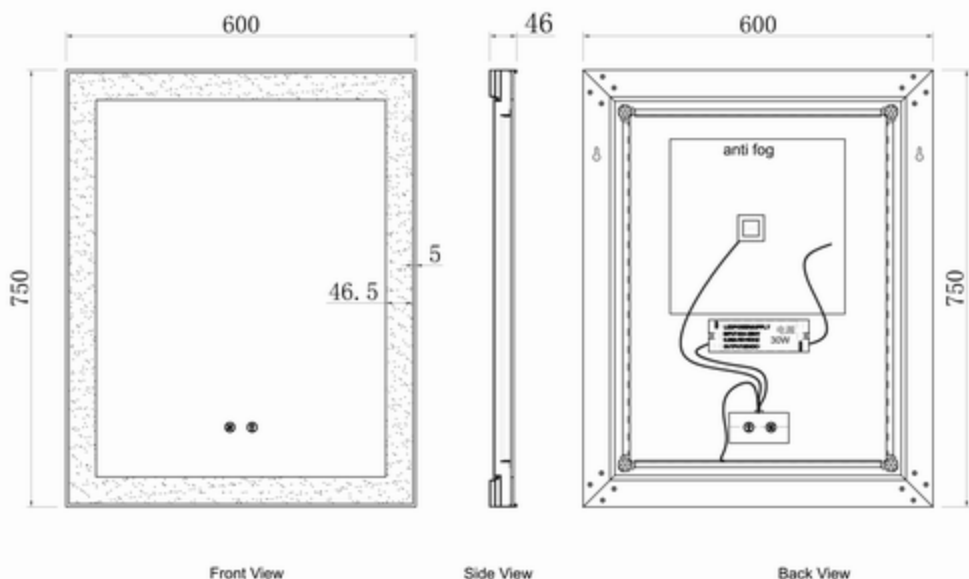

- Frame: Matte black aluminum
- Edge: Frosted for a soft glowing effect
- Lighting: LED backlit with acrylic diffuser
- Brightness Control: Dimming function for adjustable light
- Color Temperature: 6000K
- Feature: Built-in anti-fog to keep the mirror clear after showers

CONTACT US AT:

✉ support@serabathroomdesigns.com

☎ 1-833-411-7372

QUICK START

1. Turn OFF power at the breaker (verify with tester).
2. Locate studs and mark centerline
3. Install hanging bar/brackets level.
4. Make hard-wired electrical connections.
5. Hang mirror; lock-catch for horizontal mount.
6. Restore power; test touch sensors (light, anti-fog).

SAFETY & COMPLIANCE

- Installation by a licensed electrician only.
- Connect to a GFCI-protected, properly grounded circuit (120 V~ 60 Hz).
- Do not connect to any wall dimmer (ELV/triac). Use a standard ON/OFF switch if desired; dimming happens on the mirror.
- Two-person lift required; use PPE.
- Mount into wall studs whenever possible; use proper anchors for wall type.



DANGER



GFCI Protected



No wall dimmer



Ground properly



Two-person lift



PPE

CONTACT US AT:



support@serabathroomdesigns.com



1-833-411-7372



www.serabathroomdesigns.com

WHAT'S IN THE BOX & TOOLS

INCLUDED



Mirror
assembly



Hanging
bar



Wall
screws
(x2)



Anchors
(x2)

TOOLS NEEDED



Band
tap



Level



Pencil



PPE



Drill
bits

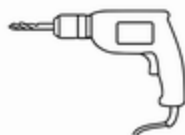

Electronic
drill



Cross
screwdriver



Stud
finder

CONTACT US AT:

✉ support@serabathroomdesigns.com

☎ 1-833-411-7372



HARDWIRE INSTRUCTIONS

Warning: Manufacturer's warranty shall be void if product is not installed by a licensed professional

Prior to commencing installation, please ensure the following:

- The wall where the product is being installed is able to support the weight of the product
- The main electrical supply has been powered off to complete installation

IMPORTANT: Wiring Instructions for Canada & USA

This fixture's wiring colors may not align with standard North American guidelines. For a safe installation, please re-identify the fixture wires with electrical tape as follows:

LIVE: Wrap black tape on the fixture's White wire. Connect this to your home's Black (Live) wire.

NEUTRAL: Wrap white tape on the fixture's Black wire. Connect this to your home's White (Neutral) wire.

GROUND: Connect the Green wire to your home's Green or Bare Copper ground wire.

Please consult a licensed electrician if you are unsure.

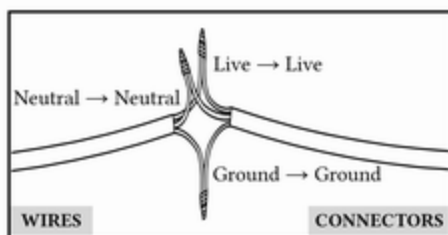
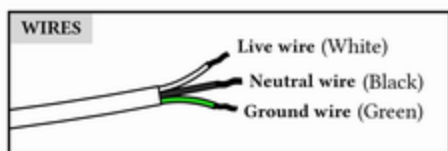

Important

- Hard-wire only. Do not attach a cord-and-plug.
- Use listed wire connectors; make all splices inside approved boxes.
- Do not use a wall dimmer. Use a standard ON/OFF switch if wall control is required.

CONTACT US AT:

✉ support@serabathroomdesigns.com

☎ 1-833-411-7372

🌐 www.serabathroomdesigns.com

WALL MOUNTING INSTRUCTIONS

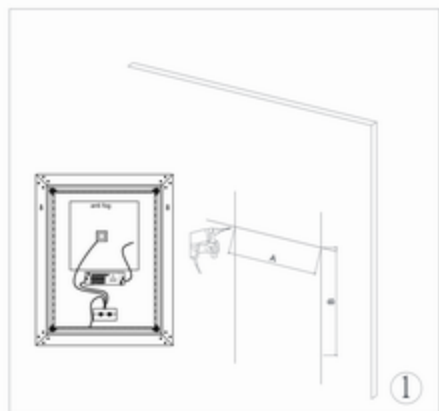

Measure the distance of the mounting hole.
Drill holes with a suitable sized drill.



Insert the anchor and mounting screw into the wall.



Connect the mirror wires with your main wires and hang the mounting hole to the screw on the wall.

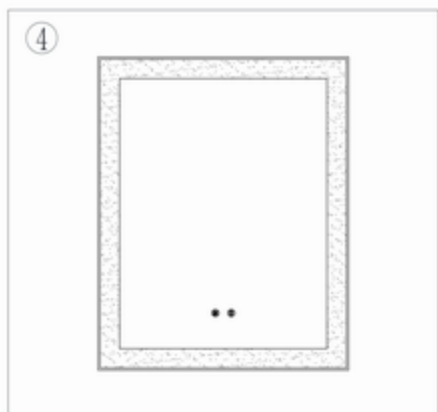

Peel off protective film and clean the mirror with damp cloth.

CONTACT US AT:

✉ support@serabathroomdesigns.com

☎ 1-833-411-7372

OPERATION & FEATURES



MIRROR DEFOGGING USE

Short touch the left Touch sensor to turn on / off the mirror defogging function.



MIRROR LIGHT USE

Short touch the right Touch sensor to turn on / off the mirror light.

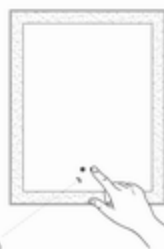

DIMMING LIGHT USE

Long touch the right Touch sensor to dimming the mirror light.

15%, 50%, and 100% dimming levels.

CONTACT US AT:

✉ support@serabathroomdesigns.com

☎ 1-833-411-7372

🌐 www.serabathroomdesigns.com

CARE & CLEANING AND TROUBLESHOOTING

CARE & CLEANING



Wipe with a soft, lint-free cloth; mild non-ammonia cleaner.



Do not use abrasives, pads, acids, or solvents.



Apply cleaner to cloth, not directly on sensor areas.

TROUBLESHOOTING (QUICK FIXES)



No light at install: Confirm breaker ON, correct wiring, internal quick-connects fully seated.



Touch unresponsive: Power cycle at breaker for 60 seconds; clean/dry glass over sensors.



Buzz/Hum: Ensure unit is not on a wall dimmer; verify solid ground.



Anti-fog not warming: Ensure left sensor is ON; feature auto-turns-off after 1 hour.

CONTACT US AT:



support@serabathroomdesigns.com



1-833-411-7372



www.serabathroomdesigns.com