

# Pull out Single-Handle Lavatory Faucet Installation

## INSTALLATION MANUAL Tools You Will Need :

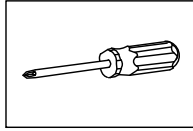
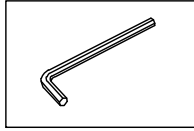
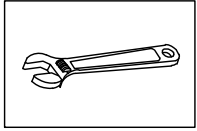

Adjustable wrench Hexagon wrench Phillips Screwdriver

### Notes before installation :

1. Please check that all components are present.
2. Before installation ensure that all feed lines are clear of debris and on/off valve is present.
3. Ensure water pressure is between 20-125 PSI (includes combination of hot and cold feed lines).
4. Pictures in the manual are general in content and may not represent exactly your purchased faucet. If you are having difficulties please contact a professional plumber.
5. If you will be away from home for an extended period you should shut off the main water supply.

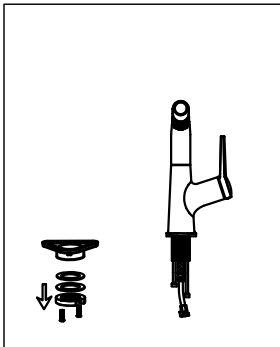

1. Remove lock-nut, metal and rubber washer and hose connector if installed.

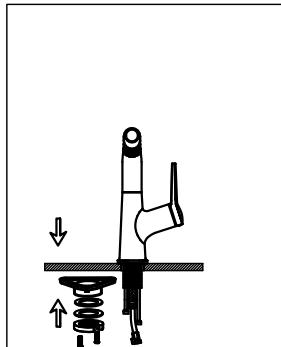

2. Install faucet through center hole, re-install rubber and metal washer followed by the lock-nut. Re-install hose connector if removed insuring small rubber washer is also installed. Using a screwdriver tighten the lock-nut screws so that the faucet is secure and will not twist.

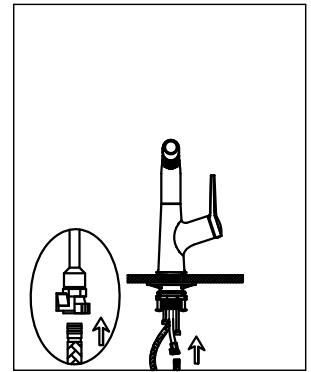

3. Push pull-out hose in to the hose connector until you hear a click sound.

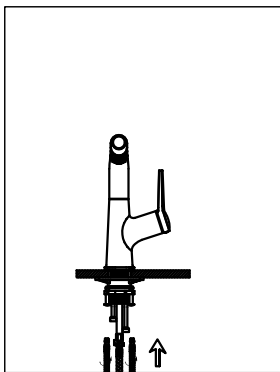

4. Screw and tighten the hot and cold flexible lines to the corresponding faucet connectors. Using a wrench ensure that the copper faucets lines are stable as you tighten the braided feed lines.

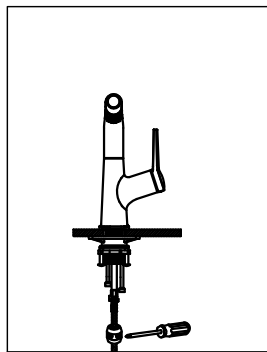

5. Proper installation of the hose weight kit will ensure that the spray head retracts smoothly. On the spray side of the hose, measure 15" down from the body of the faucet. Install the hose weight kit at this point. Pull out on the spray head. It should move easily and retract smoothly. Reposition the hose weight kit as necessary.

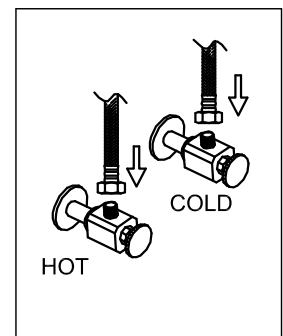

6. Attach flexible hose to water supply.

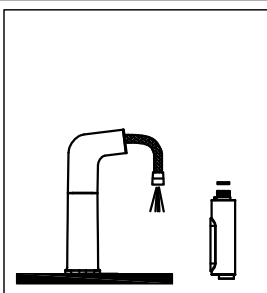

7. Hold on to the spray-head hose, unscrew spray head and remove it along with the rubber washer. Turn on the faucet to flush the hose and feed line for 1-minute to flush debris. Turn off faucet and re-install the rubber washer and spray head.

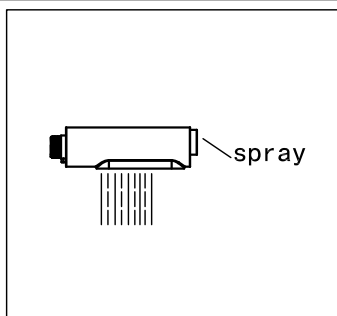

8. Turn the faucet on and press the top of the spray head button to change to Spray.

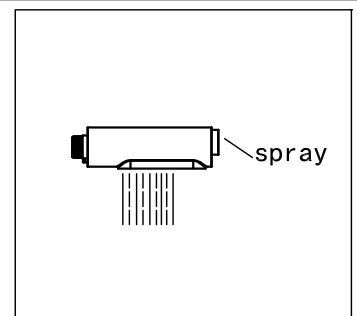

9. Turn the faucet on and press the bottom of the spray head button to change to stream.