

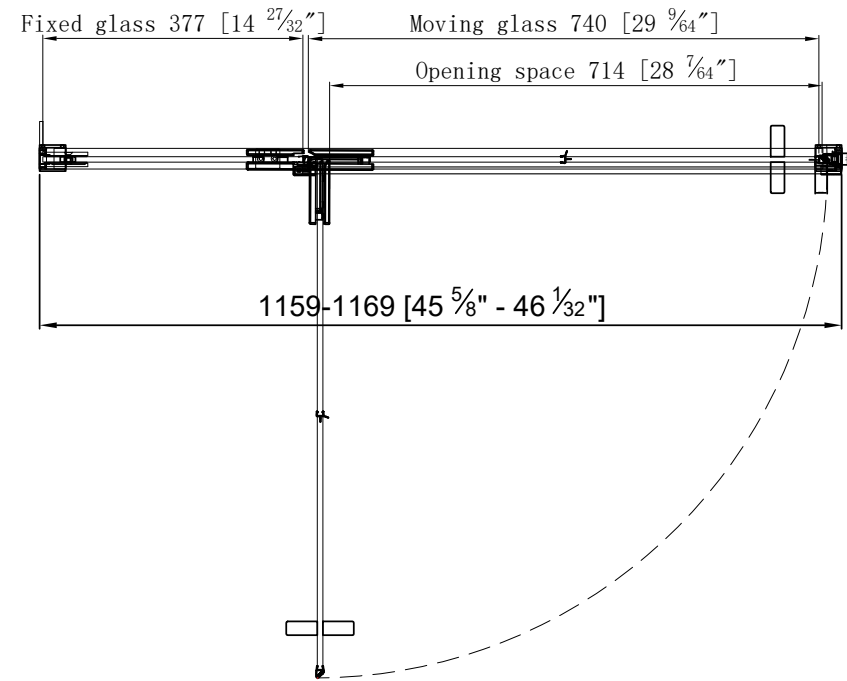







Front view

BOM						
No.	Name	Drawing	Spec/mm	Qty	Material	Remark
1	Wall mount			2PCS	SUS 304	
2	Hinge			2PCS	SUS 304	
3	Fixed glass		1997*377*8	1PCS		
4	Wall Profile		2000	1PCS	SUS 304	
5	Wall hinge			2PCS	SUS 304	
6	Waterproof fixing L/R			2PCS	SUS 304	
7	Waterproof			1PCS	SUS 304	
8	Waterproof fixing			1PCS	SUS 304	
9	Glass clip			1PCS	SUS 304	
10	Support bar		1115	1PCS	SUS 304	
11	Magnetic seal		2000	2PCS	PVC+ magnetic powder	
12	Wall profile		2000	1PCS	SUS 304	
13	Moving glass		1977*740*8	1PCS		
14	Seal		1997	1PCS	PVC	
15	Handle		Hole distance 900	1PCS	SUS 304	
16	Bottom seal		770	1PCS	PVC	



2WFP-487936-BGD-BR-DV-PKG

BOM						
No.	Name	Drawing	Spec/mm	Qty	Material	Remark
1	Connector			1PCS	SUS 304	
2	Glass clip			1PCS	SUS 304	
3	Support bar		817	1PCS	SUS 304	
4	Wall hinge			2PCS	SUS 304	
5	Wall profile		2000	1PCS	SUS 304	
6	Side panel		1997*832*8	1PCS		
7	Magnetic seal		1997	1PCS	PVC+ magnetic powder	
8	Waterproof fixing L/R			2PCS	SUS 304	

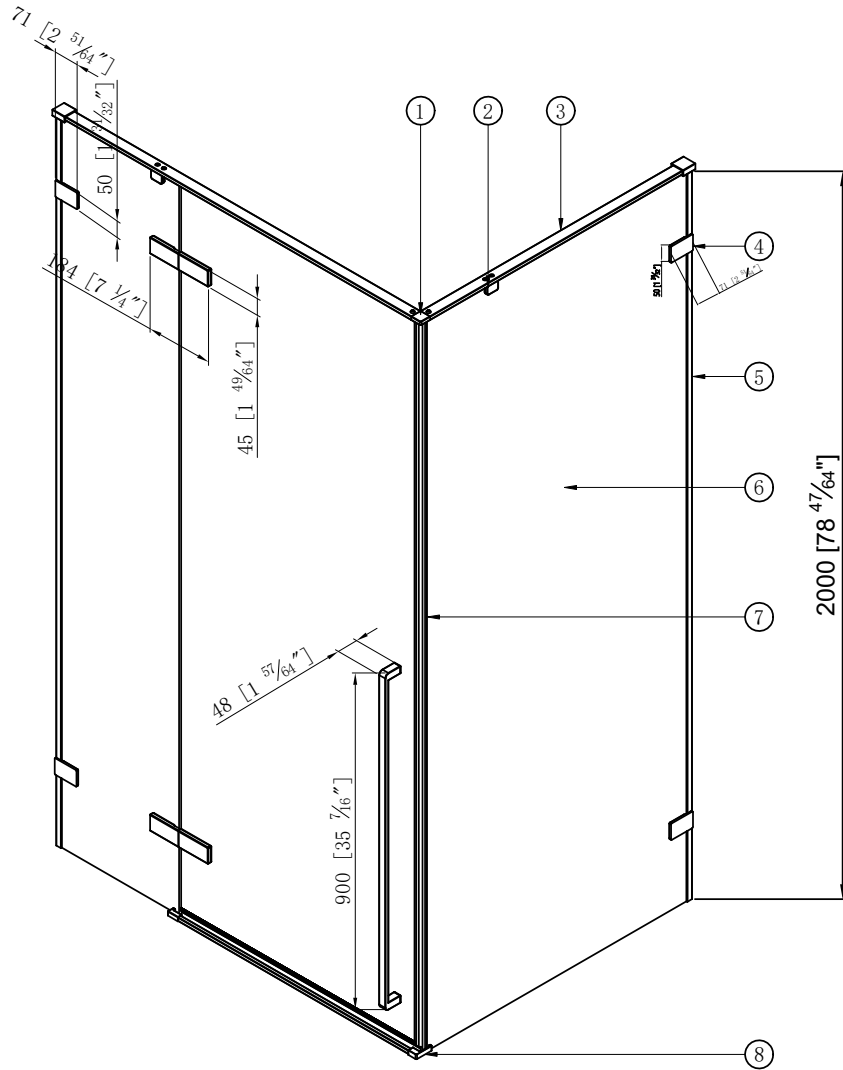

Front view

